

KOMATSU®

HD325-7

With Tier 3 Engine

GROSS HORSEPOWER

386 kW 518 HP

NET HORSEPOWER

371 kW 498 HP

MAXIMUM GVW

69280 kg 152,740 lb

**HD
325**

OFF-HIGHWAY TRUCK



Photo may include optional equipment.

WALK-AROUND

Productivity Features

- High performance Komatsu SAA6D140E-5 engine
Net horsepower 371 kW **498 HP**
- Mode selection system
(Variable Horsepower at Economy Mode)
- Automatic Idling Setting System (AISS)
- 7-speed, fully automatic K-ATOMiCS transmission
- Fully hydraulic controlled wet multiple-disc brakes and retarder; Retarder absorbing capacity (Continuous descent) 662 kW **887 HP**
- Long wheelbase and wide tread
- Large high strength body
Heaped capacity 24 m³ **31.4 yd³**
- Small turning radius 7.2 m **23'7"**
- Automatic retard speed control (ARSC)(Option)
- Automatic spin regulator (ASR) (Option)

Easy Maintenance

- Advanced monitoring system
- Wet multiple-disk brakes and fully hydraulic braking system
- Extended oil change interval
- Centralized arrangement of filters
- Centralized greasing points
- Flanged type rim
- Electric circuit breakers
- Centralized greasing points

Environment Friendly

- Komatsu SAA6D140E-5 engine is North American EPA Tier 3 and EU Stage 3A emission certified
- Low operation noise
- Lead-free radiator
- Brake cooling oil recovery tank



Komtrax equipped machines can send location, SMR and operation maps to a secure website utilizing wireless technology. Machines also relay error codes, cautions, maintenance items, fuel levels, and much more.

GROSS HORSEPOWER
386 kW **518 HP** @ 2000 rpm

NET HORSEPOWER
371 kW **498 HP** @ 2000 rpm

MAXIMUM GVW
69280 kg **152,740 lb**

Operator Environment

- Wide, spacious cab with excellent visibility
- Ergonomically designed cab
- Easy-to-see instrument panel
- Ideal driving position settings
- K-ATOMiCS with “Skip-Shift” function
- Hydropneumatic suspension
- Built-in ROPS/FOPS Level 2
- Viscous cab mounts
- Electric body dump control lever
- Supplementary steering and secondary brakes
- AM/FM radio with cassette



Photo may include optional equipment.

Reliability Features

- Komatsu components
- Highly rigid frames
- Rigorous dump body design
- Reliable hydraulic system
- Sealed DT Connectors

PRODUCTIVITY FEATURES

Komatsu Technology



ecology & economy - technology 3

Komatsu's new "ecot3" engines are designed to deliver optimum performance under the toughest of conditions while meeting the latest environmental regulations. This engine is Tier 3 EPA, EU Stage 3A and Japan emissions certified. "ecot3" – ecology and economy combined with Komatsu technology to create a high performance engine without sacrificing power or productivity.

High performance Komatsu SAA6D140E-5 engine

This engine delivers faster acceleration and higher travel speeds with high horsepower per ton. Advanced technology, such as Common Rail Injection system (CRI), air-to-air aftercooler, efficient turbo-charger, and heavy-duty cooled EGR enables the engine to be North American EPA Tier 3 and EU stage 3A emission certified. High torque at low speed, impressive acceleration, and low fuel consumption ensure maximum productivity.

Mode selection system

The system allows selection of the appropriate mode between <Power mode > or <Economy mode> according to each working condition. The mode is easily selected with a switch in the operator's cab.

Power mode

Great productivity can be attained by taking full advantage of high output power. It is appropriate for job sites where larger production uphill-hauling is required.

Economy mode (variable horsepower)

The engine power automatically changes depending on loaded or unloaded conditions always to use an optimum gear speed. It is appropriate for light work on flat ground.

Automatic Idling Setting System (AISS)

This system facilitates quick engine warm-up and cab cooling/warming. When setting the system ON, engine idle speed is kept at 945 rpm when coolant temperature is 50°C 122°F or lower. Speed automatically returns to 725 rpm when coolant temperature reaches 50°C 122°F.



7-speed, fully automatic K-ATOMiCS transmission

The K-ATOMiCS (Komatsu Advanced Transmission with Optimum Modulation Control System) automatically selects the optimum gear according to vehicle speed, engine speed and the shift position you've chosen. This results in the best gear for any driving situation.



K-ATOMiCS (Komatsu Advanced Transmission with Optimum Modulation Control System)

Automatic Retard Speed Control (ARSC)(Option)

ARSC allows the operator to simply set the downhill travel speed and go down slopes at a constant speed. As a result, the operator can concentrate on steering. The speed can be set at increments of 1 km/h 0.6 MPH per click (±5 km/h 3.1 MPH of maximum speed adjustment) to match the optimum speed for the slope. Also, since the retarder cooling oil temperature is always monitored, the speed is automatically lowered.

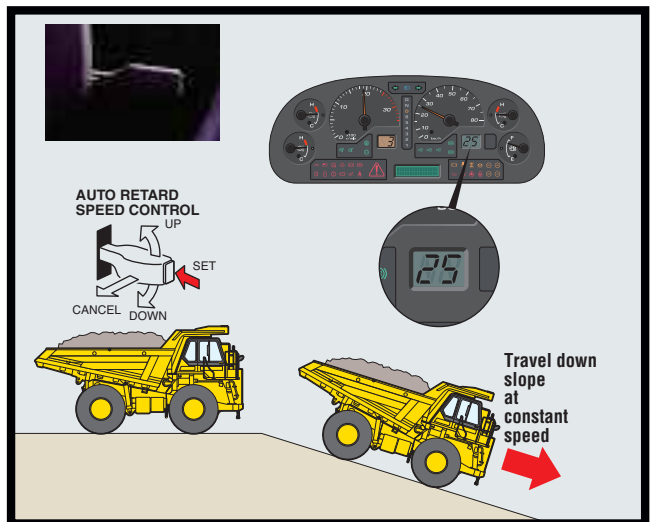

Fully hydraulic controlled wet multiple-disc brakes and retarder

Wet multiple-disc brakes ensure highly reliable and stable brake performance. The large-capacity, continuously cooled, wet-multiple disc brakes also function as a highly responsive retarder which gives the operator greater confidence at higher speeds when travelling downhill.

- Retarder Absorbing Capacity (continuous descent): 662 kW
887 HP
- Brake Surface Area (rear): 50847 cm²
7,881 in²

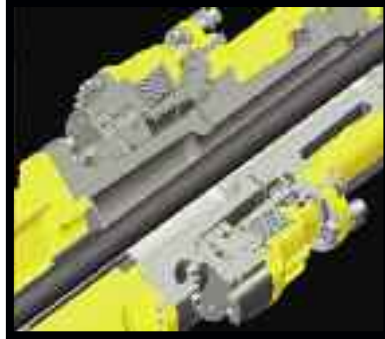

Small turning radius

The MacPherson strut type front suspension has a special A-frame between each wheel and the main frame. The wider space created between the front wheels and the main frame increases the turning angle of the wheels. The larger this turning angle, the smaller the turning radius of the truck.

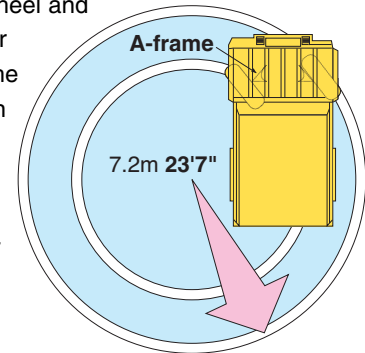

Automatic Spin Regulator (ASR) (Optional)

ASR automatically maximizes traction by preventing the rear tires from slipping on either side.

Long wheelbase and wide tread

With an extra-long wheelbase, a wide tread and an exceptionally low center of gravity, the HD325-7 hauls the load at higher speed for more production, and delivers superior driving comfort over rough terrain.

Large high strength body

A wide target area makes for easy loading with minimal soil spillage and more efficient hauling. The body is built of 130 kg/mm² **184,900 PSI** wear-resistant high-tensile steel with a Brinell hardness of 400. The V-shape design also increases structural strength and provides excellent load stability.



OPERATOR ENVIRONMENT

Wide, spacious cab with excellent visibility

Wide windows in the front, side and back, plus plenty of space in the richly upholstered interior, provide quiet, comfortable environment from which to see and control every aspect of operation. Front and side under view mirrors have also been added.

Ergonomically designed cab

The ergonomically designed operator's compartment makes it very easy and comfortable for the operator to use all the controls. The result is more confident operation and greater productivity.

Easy-to-see instrument panel

The instrument panel makes it easy to monitor critical machine functions. In addition, a caution light warns the operator of any problems that may occur. Problems are recorded in the monitor and indicated as service codes. This makes the machine user friendly and easy to service.

Ideal driving position settings

The 5-way adjustable operator seat and the tilt-telescopic steering column create an optimum driving posture for increased driving comfort and more control over the machine's operations. The suspension seat dampens vibrations transmitted from the machine, which reduces operator fatigue and holds the operator securely to assure confident operation. 78 mm 3" width seat belt is provided as standard equipment.



Hydropneumatic suspension for all terrains

The hydropneumatic suspension assures a comfortable ride even over rough terrain and ensures maximum productivity and operator confidence.

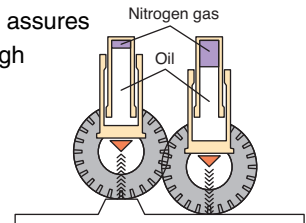

K-ATOMiCS with “Skip-shift” function

An electronically controlled valve is provided for each clutch pack in the transmission for independent clutch engagement/disengagement. It enables an ideal change in clutch modulation pressure and torque cut-off timing in response to travel conditions. This system and newly added “skip-shift” function ensure smooth shifting and responsive acceleration.

“Skip-shift” function

Optimum travel speed automatically selected in response to angle of ascent. This reduces the downshift frequency and provides smoother operation.

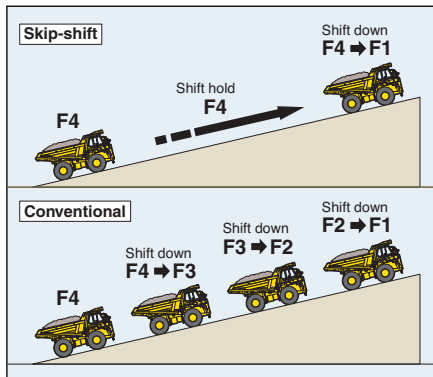

Built-in ROPS/FOPS Level 2

These structures conform to ISO3471 and SAE J1040 ROPS standards and ISO 3449 and SAE J231 FOPS level 2 standards.



Viscous cab mounts

Viscous mounts reduce the noise transmitted to the cab and achieve a quiet 77 dB(A) noise level.

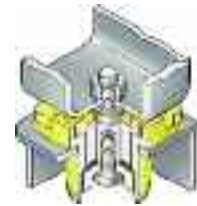

Electric body dump control lever

The low effort lever makes dumping easy. A positioning sensor is installed for dump body control which significantly reduces the shock made by the lowering of the dump body.



Supplementary steering and secondary brakes

Supplementary steering and secondary brakes are standard features.

Steering: ISO 5010, SAE J1511, SAE J53

Brakes: ISO 3450, SAE J1473



RELIABILITY FEATURES

Komatsu components

Komatsu manufactures the engine, torque converter, transmission, hydraulic units, and electrical parts on this dump truck. Komatsu dump trucks are manufactured with an integrated production system under a strict quality control system.

High-rigidity frame

Cast-steel components are used in the main frame for high-stress areas where loads and shocks are most concentrated.

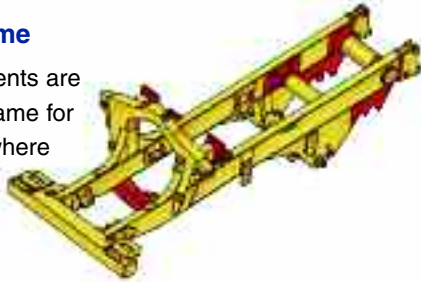

Rigorous dump body design

The standard dump body is made of 130 kg/mm² **184,900 PSI** high-tensile-strength steel for excellent rigidity and reduced maintenance cost. The V-shape design also increases structural strength. The side and bottom plates of the dump section are reinforced with ribs for added strength.

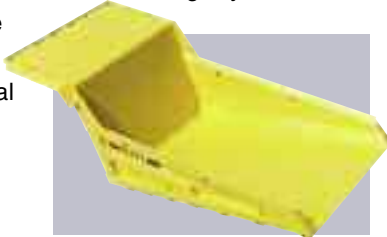

Reliable hydraulic system

The oil cooler is installed in the radiator lower tank, improving the reliability of the hydraulic system during sudden temperature rises. In addition to the main filter, a 25-micron line filter is installed at the entrance to the transmission control valve. This system helps to prevent secondary faults.

Sealed DT connectors

Main harnesses and controller connectors are equipped with sealed DT connectors providing high reliability, water resistance, and dust resistance.



Pedal-operated secondary brake

If there should be a failure in the foot brake, the parking brake and front disc brakes are activated as pedal operated secondary brake. In addition, when hydraulic pressure drops below the rated level, the parking brake is automatically actuated.



Lead-free radiator

In addition to compliance with emission regulations, a lead-free aluminum core is utilized for the radiator to comply with global environmental requirements.

Brake cooling oil recovery tank

To protect the environment, a tank is installed to recover brake cooling oil in the event of brake floating seal leakage.

Flat face-to-face O-ring seals

Flat face-to-face O-ring seals are used to securely seal all hydraulic hose connections and to prevent oil leakage.

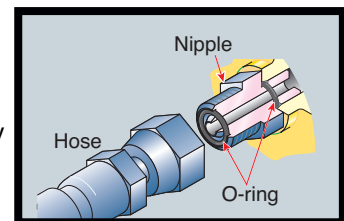

Protection by electronic control

Item	Function
Downshift inhibitor	Even if the driver downshifts accidentally, a speed appropriate to the current gear is automatically set, preventing over-runs.
Over-run inhibitor	When descending grades, if vehicle's speed surpasses maximum for current gear, rear brakes automatically operate, preventing over-runs.
Reverse inhibitor	The vehicle is prevented from moving backward when operating the body.
Forward/Reverse shift inhibitor	This device makes it impossible to shift from forward to reverse when the vehicle's speed surpasses 4 km/hr 2.5 mph .
Anti-hunting system	When running near a shift point, a smooth automatic shifting takes place.
Neutral engine start system	The engine is prevented from starting when the shift lever is not in neutral.

EASY MAINTENANCE

Advanced monitoring system

The Komatsu advanced monitoring system identifies maintenance items, reduces diagnostic times, indicates oil and filter replacement hours and displays abnormality codes. This monitor system helps to maximize machine production time.



Wet multi-disc brakes and fully hydraulic braking systems mean lower maintenance costs and higher reliability. Wet disc brakes are fully sealed to keep contaminants out, reducing wear and maintenance. Brakes require no adjustments for wear, leading to even lower maintenance. Added reliability is designed in the braking system with three independent hydraulic circuits providing hydraulic backup should one of the circuits fail. Fully hydraulic braking systems eliminate the air system so air bleeding is not required and water condensation, that can lead to contamination, corrosion and freezing, is eliminated.

Extended oil change intervals

In order to minimize operating costs, oil change intervals have been extended:

- Engine oil: 500 hours
- Hydraulic oil: 4,000 hours

Centralized arrangement of filters

The filters are centralized so that they can be serviced easily.



Flange type rim

Flange type rims provide easy removal/installation of tires.



Electric circuit breaker

A circuit breaker is used in important electric circuits that need to be restored quickly time when a problem occurs in the electrical system.



Centralized greasing points (Option)

Greasing points are centralized at three locations.



SPECIFICATIONS



ENGINE

Model KOMATSU SAA6D140E-5
 Type Water-cooled, 4-cycle
 Aspiration Turbo-charged, air-to-air after-cooled, cooled EGR
 Number of cylinders 6
 Bore x stroke 140 mm x 165 mm **5.5" x 6.5"**
 Piston displacement 15.24 ltr. **930 in³**
 Horsepower
 SAE J1995 Gross 386 kW **518 HP**
 ISO 9249 /SAE J1349 Net 371 kW **498 HP**
 Rated rpm 2,000 rpm
 Fan drive type Mechanical
 Maximum torque 2167 N·m 221 kg·m **1,600 lb·ft**
 Fuel system Direct injection
 Governor Electronically controlled
 Lubrication system :
 Method Gear pump, force-lubrication
 Filter Full-flow type
 Air cleaner Dry type with double elements
 and precleaner, plus dust indicator
 EPA Tier 3 and EU Stage 3A emission certified.



TRANSMISSION

Torque converter 3-elements, 1-stage, 2-phase
 Transmission Full-automatic, planetary type
 Speed range 7 speeds forward and 1 reverse
 Lockup clutch Wet, single-disk clutch
 Forward Torque converter drive in 1st gear,
 direct drive in 1st lockup and all higher gears
 Reverse Torque converter drive
 Shift control Electronic shift control with automatic
 clutch modulation in all gears
 Maximum travel speed 70 km/h **43.5 mph**



AXLES

Rear axle Full-floating
 Final drive type Planetary gear
 Ratios:
 Differential 3.125
 Planetary 4.737



SUSPENSION SYSTEM

Independent, hydropneumatic suspension cylinder with fixed throttle to dampen vibration
 Effective cylinder stroke (front suspension) 250 mm **9.8"**
 Rear axle oscillation:
 Oil stopper 6.8°
 Mechanical stopper 8.1°



STEERING SYSTEM

Type Fully hydraulic power steering
 with two double-acting cylinder
 Supplementary steering Manual control
 (meets ISO 5010, SAE J1511 and SAE J53)
 Minimum turning radius 7.2 m **23'7"**
 Maximum steering angle 43°



CAB

Dimensions comply with ISO 3471 and SAE J1040-1988c ROPS
 (Roll-Over Protective Structure) standards.



MAIN FRAME

Type Box-sectioned structure



BRAKES

Brakes meet ISO 3450 and SAE 1473 standards.
 Service brakes:
 Front Full-hydraulic control, caliper disc type
 Rear full-hydraulic, oil-cooled, multiple-disc type
 Parking brake Spring applied, multiple-disc type
 Retarder Oil-cooled, multiple-disc rear brakes act as retarder
 Secondary brake Manual pedal operation
 When hydraulic pressure drops below the rated level,
 parking brake is automatically actuated
 Brake surface
 Front 968 cm² **150 in²**
 Rear 50847 cm² **7,881 in²**



BODY

Capacity:
 Struck 18 m³ **23.5 yd³**
 Heaped (2:1, SAE) 24 m³ **31.4 yd³**
 Payload, maximum 36.5 metric tons **40 U.S. tons**
 rated 32 metric tons **35 U.S. tons**
 Material 130 kg/mm² **184,860 psi**
 high-tensile-strength steel
 Structure V-shape body
 Material thickness:
 Bottom 19 mm **0.75"**
 Front 12 mm **0.47"**
 Sides 9 mm **0.35"**
 Target area
 (inside length x width) 5500 mm x 3380 mm **18'1" x 11'1"**
 Dumping angle 48°
 Height at full dump 7925 mm **26'0"**
 Heating Exhaust heating



HYDRAULIC SYSTEM

Hoist cylinder Twin, 2-stage telescopic type
 Relief pressure 20.6 MPa 210 kg/cm² **2,990 psi**
 Hoist time 10 sec



WEIGHT (APPROXIMATE)

Empty weight 31600 kg **69,700 lb**
 Gross vehicle weight with 32 metric ton
 (35 U.S.ton) payload 63680 kg **140,390 lb**
 Max. gross vehicle weight:
 Standard tire 69280 kg **152,740 lb**
 Not to exceed max. gross vehicle weight, including options, fuel
 and payload
 Weight distribution:
 Empty: Front axle 51.7%
 Rear axle 48.3%
 Loaded: Front axle 33%
 Rear axle 67%



TIRES

Standard tires 18.00-33-32PR



SERVICE REFILL CAPACITIES

Fuel tank 484 ltr. **127.9 U.S. Gal**
 Engine oil50 ltr. **13.2 U.S. Gal**
 Torque converter, transmission and
 retarder cooling90 ltr. **23.8 U.S. Gal**
 Differential45 ltr. **11.9 U.S. Gal**
 Final drives (total)30 ltr. **7.9 U.S. Gal**
 Hydraulic system129 ltr. **34.1 U.S. Gal**
 Suspension (total)44.2 ltr. **11.7 U.S. Gal**



DIMENSIONS

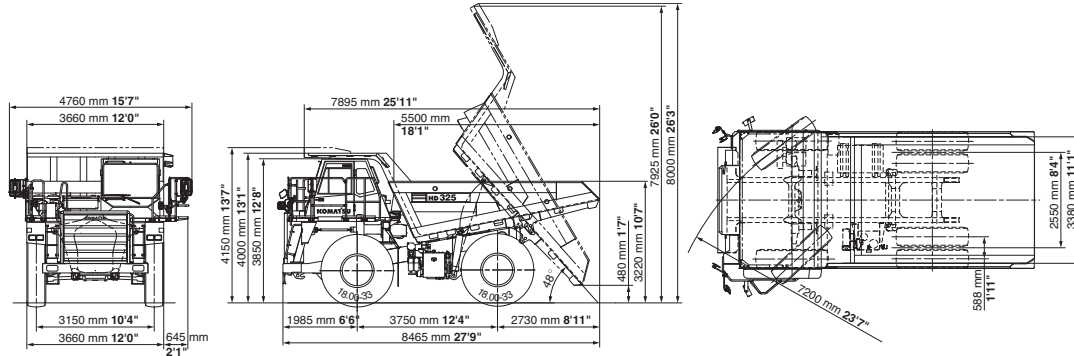

TRAVEL PERFORMANCE

To determine travel performance:
 Read from gross weight down to the percent of total resistance. From this weight resistance point, read horizontally to the curve with the highest obtainable speed range, then down to maximum speed. Usable rimpull depends upon traction available and weight on drive wheels.

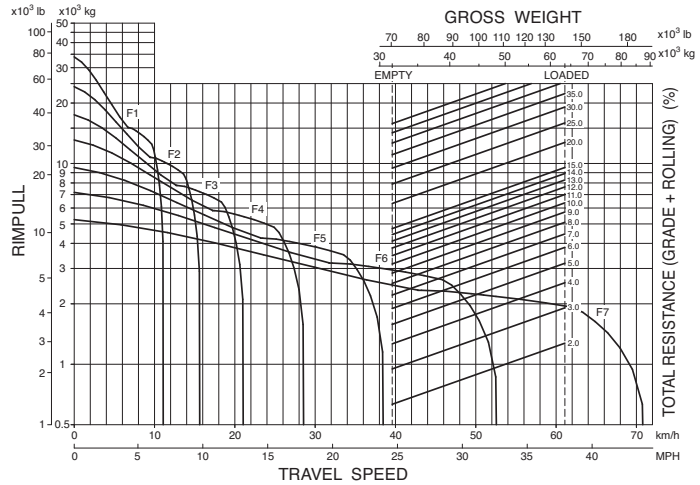

BRAKE PERFORMANCE

To determine brake performance:
 These curves are provided to establish the maximum speed and gearshift position for descents on roads with a given distance. Read from gross weight down to the percent of total resistance. From this weight-resistance point, read horizontally to the curve with the highest obtainable speed range, then down to maximum descent speed the brakes can handle without exceeding cooling capacity.

Grade distance: Continuous descent

Grade distance: 450 m (1,480 ft)

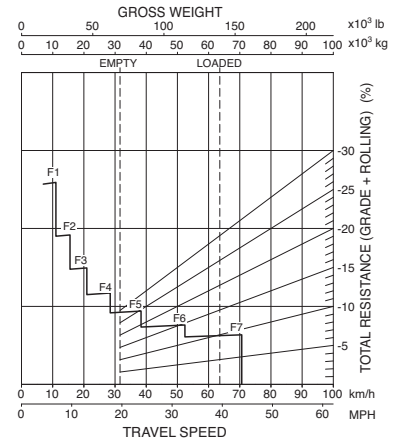
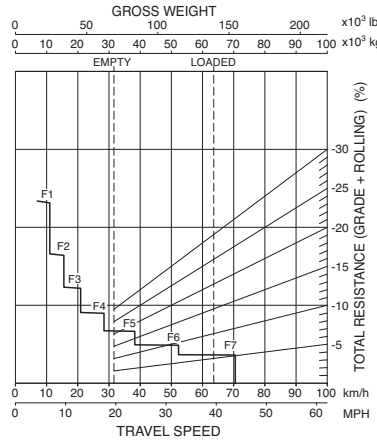

Grade distance: 600 m (1,970 ft)

Grade distance: 900 m (2,950 ft)

Grade distance: 1500 m (4,920 ft)

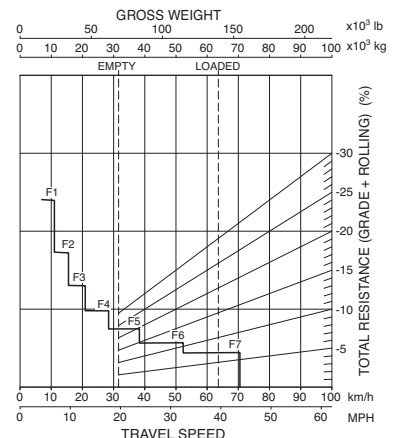
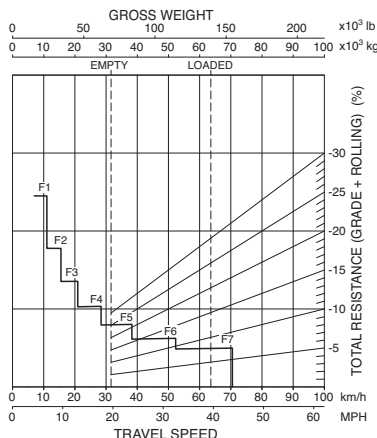
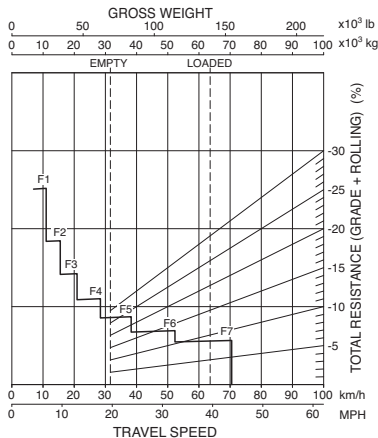



STANDARD EQUIPMENT

ENGINE:

- AISS (Automatic Idling Setting System)
- Alternator, 75A/24V
- Batteries, 2 x 12V/170Ah
- Engine, Komatsu SAA6D140E-5
- Starting motor, 1 x 11.0 kW
- Variable horsepower system

CAB:

- 12V outlet port
- Air conditioners/heater/defroster, electronically controlled
- Ashtray
- Cigarette lighter
- Cup holder
- Electronic hoist control system
- Electronic maintenance display/monitoring system
- Operator seat, reclining, suspension type with retractable 78 mm 3" width seat belt
- Passenger seat with retractable 78 mm 3" width seat belt
- Power windows (LH)

- ROPS cab with FOPS level 2, sound suppression type
- Radio, AM/FM with cassette
- Space for lunch box
- Steering wheel, tilt and telescopic
- Sunvisor
- Tinted glass
- Two doors, left and right
- Windshield washer and wiper (with intermittent feature)

LIGHTING SYSTEM:

- Back-up light
- Hazard lights
- Headlights with dimmer switch
- Indicator, stop and tail lights

GUARD AND COVERS:

- Drive shaft guard (front and rear)
- Engine and transmission underguards
- Exhaust thermal guard
- Fire protective covers
- Tire guards

OTHER:

- Alarm, backup
- Catwalk with hand rails
- Coolant temperature alarm and light
- Electric circuit breaker, 24V
- Front brake cut-off system
- Hand rails for platform
- Horn, electric
- KOMTRAX®
- Ladders, left and right hand side
- Overrun warning system
- Rearview mirrors and underview mirrors RH, LH
- Side markers
- Supplementary steering, automatic



OPTIONAL EQUIPMENT

CAB:

- Seat, air suspension

BODY:

- Spill guard, 150 mm 6" [90 kg 200 lb]
- 24 m³ 31.4 yd³ body w/o liner
- 24 m³ 31.4 yd³ rock body w/ liner

GUARD:

- Platform guard, Right hand side [35 kg 80 lb]

LIGHTING SYSTEM:

- Fog lights
- Work light, RH and LH side

TIRES:

- 18.00-33-32PR
- 18.00 R33

OTHER:

- Automatic Retard Speed Control (ARSC)
- Automatic Spin Regulator (ASR)
- Gas charge tool
- Muffler (no body heating type)

Standard equipment may vary for each country. This specification sheet may contain attachments and optional equipment that are not available in your area. Please consult your Komatsu distributor for detailed information.

KOMATSU®

