

KOMATSU®

PC2000-8

HORSEPOWER

Gross: 728 kW 976 HP @ 1800 rpm

Net: 713 kW 956 HP @ 1800 rpm

OPERATING WEIGHT

Backhoe: 200000–204120 kg

440,920–450,000 lb

Loading shovel: 195000 kg

429,900 lb

PC
2000

HYDRAULIC EXCAVATOR



Photo may include optional equipment.

WALK-AROUND

Productivity and Economy

- **Fuel Efficient Machine Achieved by Total Power Management and Advanced Hydraulic System**
Fuel Consumption at Economy Mode 10% Reduced (compared with PC1800-6)
 - Hydraulic power loss reduced with advanced hydraulic system
 - On-demand fan speed and engine output control system
 - Equipped with electronically controlled variable speed fans
- **Powerful and Economical Engine**
Komatsu SAA12V140E-3 Engine with an Output of 713 kW (956 HP)
Controlled by Efficient Power Management System
 - Auto-deceleration and auto-idling system
 - Two work modes; Power and Economy

Ecology

- **EPA Tier 2 Emission Certified Komatsu Engine**
- **New Technology Produces Remarkably Low Environmental Noise**
Dynamic Noise 8 dB lower than PC1800-6
 - Power module packaging and noise absorbing blades trap noise inside
 - 3-D hybrid fan minimizes air turbulence noise

See pages 4, 5.

Easy Repair and Maintenance

Low R&M Cost Sustained by Simplified and Reliable System with Long Service Life

- **Simplified and Durable Structure**
 - Single engine and PTO drive two Komatsu HPV375+375 pumps
 - Simplified travel unit with single motor (each side)
 - Reinforced track components
 - Long life oil and filters
 - Extended life of rubber components achieved by lowering hydraulic oil temperature
- **Power Module Makes Installation and Removal of Components Easier, and Reduces Overhaul Hours and Cost**
- **Service Friendly Design**
 - Maintenance deck surrounding the power module
 - Drain ports accessible from the ground level
 - Concentration of filters
 - Large fuel tank enables 24 hours continuous machine operation
 - Auto-greasing system including bucket pins with **200 liter** 52.8 U.S.gal grease tank
- **VHMS Monitors the Machine Condition and Minimizes Machine Down Time**

See pages 6, 7, 8 and 9.

Operator Comfort

- **Newly Designed Mining Shovel Cab Provides Comfortable Operation**
 - Excellent operational visibility with extended front windshield and large twin wiper
 - Extremely low noise and vibration
Dynamic in-cab noise reduced to the same level as passenger cars
 - Rugged OPG top guard integrated into the cab
 - Easy-to-see and easy-to-use 7-inch TFT-LCD large monitor
 - Comfortable air-suspension seat
 - Automatic air conditioner
 - Highly pressurized cab
- **Bulkhead between Pump Room and Engine**
- **Emergency Stop Devices**
- **Interconnected Horn and Flashing Light**

See pages 10, 11, 12 and 13.



Photo may include optional equipment.

HORSEPOWER
Gross: 728 kW 976 HP @ 1800 rpm
Net: 713 kW 956 HP @ 1800 rpm

OPERATING WEIGHT
Backhoe
200000 – 204120 kg
440,920 – 450,000 lb
Loading shovel
195000 kg
429,900 lb

PRODUCTIVITY, ECONOMY & ECOLOGY

*In complete pursuit of total cost reduction and eco-friendliness
Evolutionary Komatsu technologies*

Komatsu Technology

Komatsu develops and produces all major components, such as engines, electronics and hydraulic components, in house. With this "Komatsu Technology" and adding customer feedback, Komatsu is achieving great advancements in technology. To achieve both high levels of productivity and economical performance, Komatsu has developed the main components with a total control system. The result is a new generation of high performance and economical excavators.

Powerful and Fuel Efficient Machine achieved by Total Power Management

PC2000-8 is equipped with the new Komatsu SAA12V140E engine that features clean, fuel efficient and powerful performance. Power losses in hydraulic system, cooling fan and PTO are reduced. Total Power Management using On-demand Power Control System succeeds in drastically reducing the fuel consumption per hour. The machine has enhanced functions that contribute to energy-saving operation including adjustable 'E mode' and 'Eco-gauge'. PC2000-8 is a new generation clean and economical machine.

Fuel consumption at E mode 10% reduced

Compared with the PC1800-6 at DH mode and 100% working efficiency.

(Fuel consumption varies depending on job conditions.)

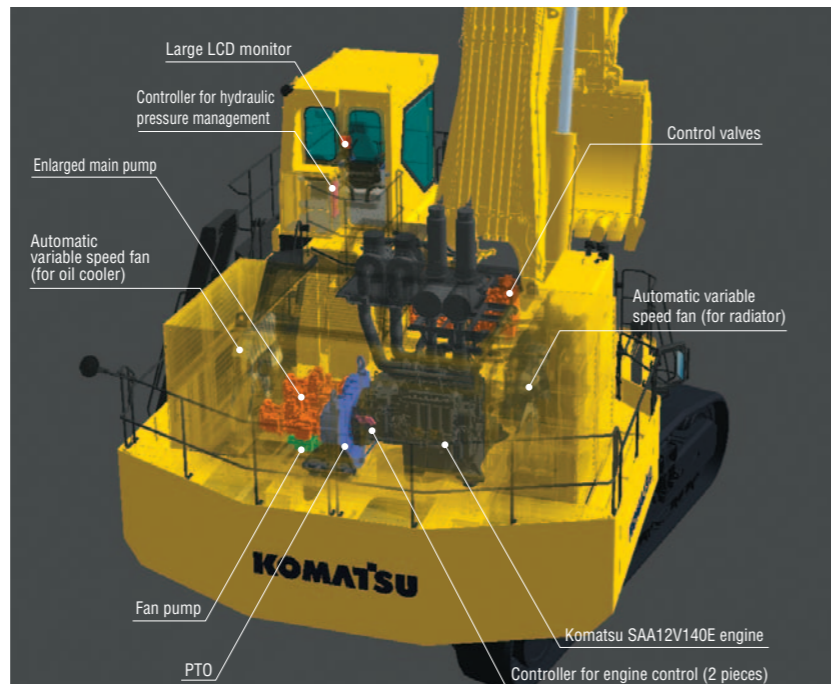

ON-DEMAND POWER OPERATION SYSTEM

On-demand fan speed and engine output control system

Controls the rotational speed of the fan according to the hydraulic oil and coolant temperature, and varies the engine output depending on the fan speed.

On-demand power control system

Controls pump absorbing horsepower and engine output automatically according to the job.

All-out power delivery system

Outputs all-out engine power when the heavy lift mode and travel is selected.

High Power Komatsu Engine 713 kW (956 HP)

Equipped with the high efficiency turbocharger with large air-to-air aftercooler, the engine delivers high output of 713 kW (956 HP). The ample engine power enables an increase in work efficiency. This engine is EPA Tier 2 emission certified.



Heavy Lift Mode

Turning the heavy lift mode switch on activates the all-out power delivery system to increase the lifting force of the boom. This mode is beneficial when handling rock and during heavy lifting applications.

Selectable Working Modes

Two established work modes are further improved. You can select Power or Economy modes using a one-touch operation on the monitor panel depending on workloads. Two E mode settings available, enabling the operator to select optimum mode that delivers the best combination of production and fuel efficiency considering working conditions.



Working mode selection switch

Advanced Environmentally Friendly Features

Eco-gauge

The Eco-gauge is provided on the right side of the monitor screen for energy saving operation. The gauge informs the operator of cumulative achievement to a predetermined fuel consumption target. By keeping the gauge indication within the green range, the operator can perform fuel-efficient operation to meet the target value.



Eco-gauge

Idling caution

To prevent unnecessary fuel consumption, an idling caution is displayed on the monitor when the engine idles for 5 minutes or more.

Auto deceleration and auto idling system

The machine is equipped with the auto deceleration system (1400 rpm), reducing operating noise as well as fuel consumption. The auto idling system enables the engine idling speed to be set at a lower speed.

Power module packaging for ultra low-noise operation

Noise sources such as the engine, cooling fan, and hydraulic pumps are packaged in the machinery house. Large sound absorbing blades attached on the air intake and exhaust outlet block noise transmission. Combined with the three dimensions hybrid cooling fan, the machine realizes environmentally-friendly operation with amazingly low-noise.



EASY REPAIR & MAINTENANCE

*Designed and built for total cost reduction
The evolution of reliability and durability*

Reduced Inspection/maintenance and Overhaul Man-hours Achieves Total Cost Reduction

Power module packaging for easy installation and removal of components

Engine, radiator, oil cooler, hydraulic pumps and PTO are packaged within the Power module. This design facilitates installation and removal of components, contributing to the reduction of maintenance transportation and overhaul hours.

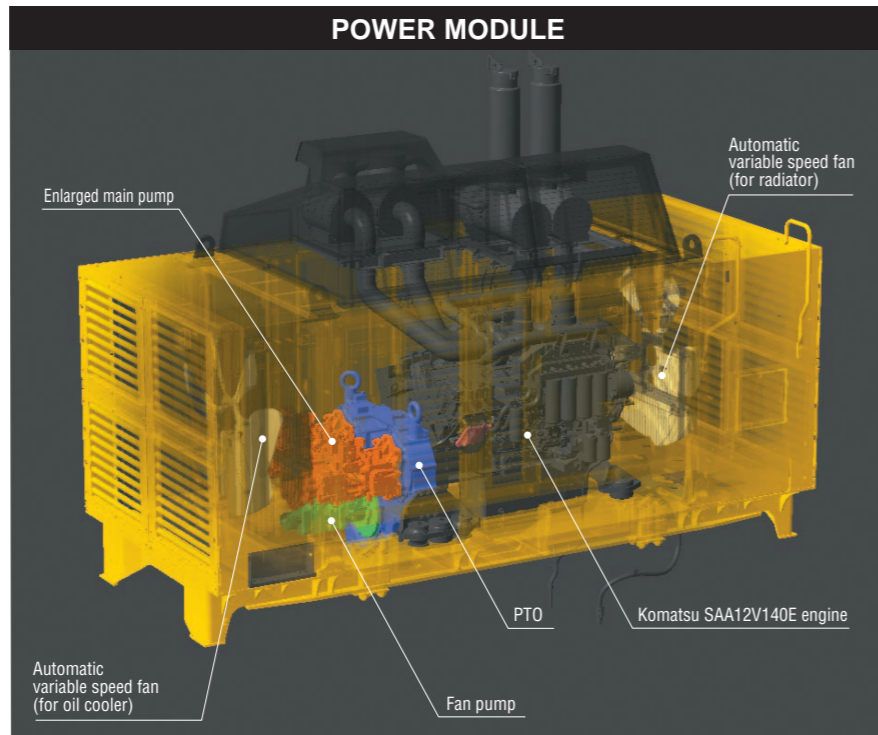

High cooling efficiency machine design

Increased oil cooler capacity lowers the heat balance temperature of hydraulic oil to realize a cooler operating machine. Heat-resistant rubber seals are used in hydraulic pumps and cylinders to significantly increase component durability. These improvements dramatically extend the service life of the hydraulic system.

Strengthened Frame Structure

Revolving frame, center frame and crawler frame are strengthened completely. The frames endure heavy-duty work and exhibit excellent durability.

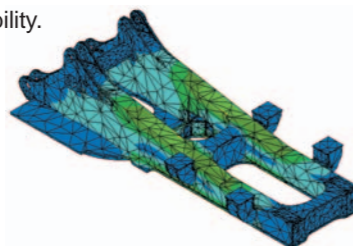

Durable Swing Circle with Triple-roller Bearing

Large capacity triple-roller bearing is used for the swing circle. The swing circle endures heavy-duty excavating and loading work, and exhibits excellent durability.

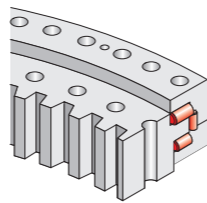

Sturdy Guard and Large Track Link

Travel motors are shielded by sturdy guards. They prevent the motors from being damaged by the thrust of rocks. Enlarged track rollers, in combination with the largest size track links, provide excellent durability.



Repair & maintenance cost Drastically reduced

Compared with current model

Simple construction and enlarged components reduce the number of parts

Use of a single-engine, enlarged hydraulic pumps and simplified hydraulic circuit enables reduced hours required for checking and maintenance. Moreover, significant reduction of number of parts contributes to reduction of overhaul man-hours, resulting in total cost reduction.

Heavy-duty Rock Bucket (optional)

Packaged wear-resistant reinforcement plates are available. The repair cost of the bucket can be considerably reduced with the new design.

* KVX materials :

Komatsu developed, wear-resistant, reinforced materials. Brinell hardness: 500 or more (180kgf/mm² class). Features high wear-resistance and less heat-induced alteration during rock digging, maintaining long term hardness.

XS Tooth

- Unique bucket tooth shape, superior digging performance
- Long-term high sharpness
- Great penetration performance
- Hammerless, safe, and easy tooth replacement (Tooth replacement time: Half the conventional machine.)

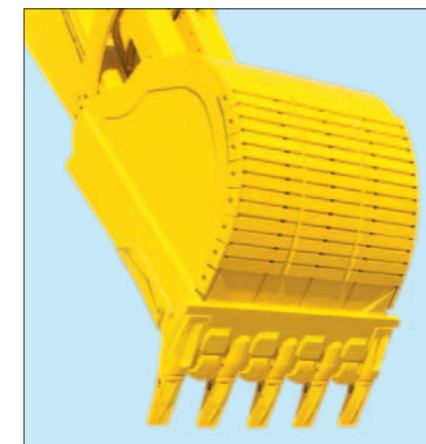

Arm Rock Protector Guards the Arm Against Impact

Arm rock protector is equipped as standard. The protector guards the arm greasing piping against impact.



Heavy-duty Rock Bucket with XS Tooth

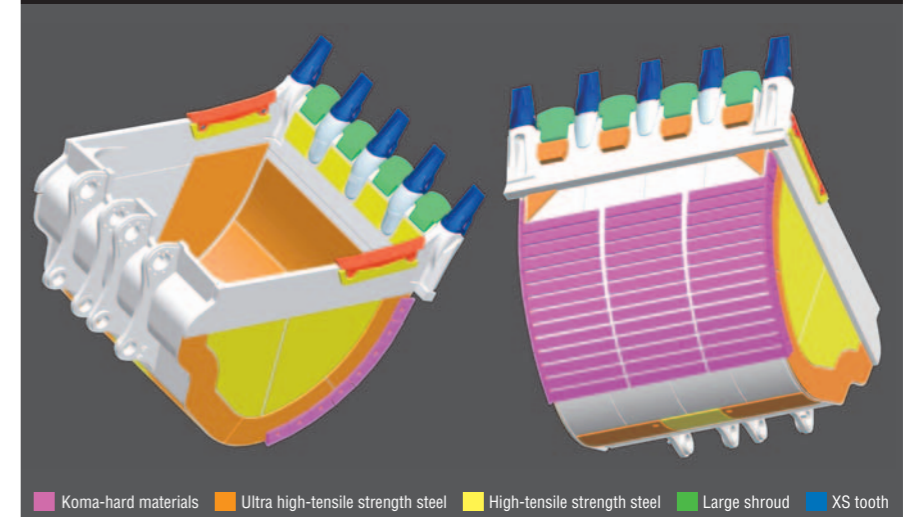

■ Koma-hard materials ■ Ultra high-tensile strength steel ■ High-tensile strength steel ■ Large shroud ■ XS tooth

Wear-resistant Float Pin

Boom top pin and arm top pin are floating type. Since the pin can freely rotate, it receives less friction load and exhibits excellent reliability and durability.

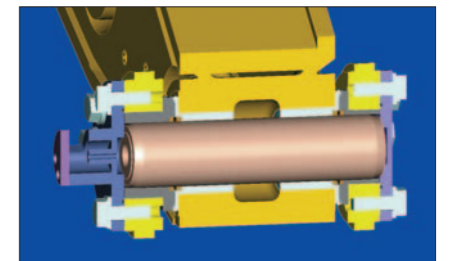

EASY REPAIR & MAINTENANCE

*Sustained high level performance
An achievement in the evolution of maintenance*

VHMS (Vehicle Health Monitoring System)

VHMS controller monitors the health conditions of major components and enables remote analysis of the machine and its operation. This process is supported by the Komatsu distributors, factory and design team. This contributes to reduced repair costs and to maintaining maximum availability.

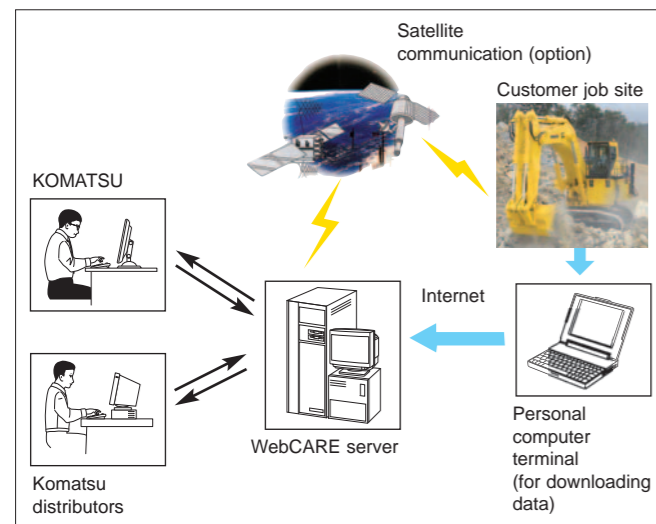

Monitor function

Controller monitors engine oil level, coolant temperature, battery charge and air clogging, etc. If controller senses any abnormality, it is displayed on the LCD.



Maintenance function

Monitor indicates replacement time of oil and filters on LCD when the replacement interval is reached.



Trouble data memory function

Monitor stores abnormalities for effective troubleshooting.

Advanced Layout for Easy Checking and Maintenance

Catwalk surrounding the power module and center walkway provides easy access to the inspection and maintenance points.

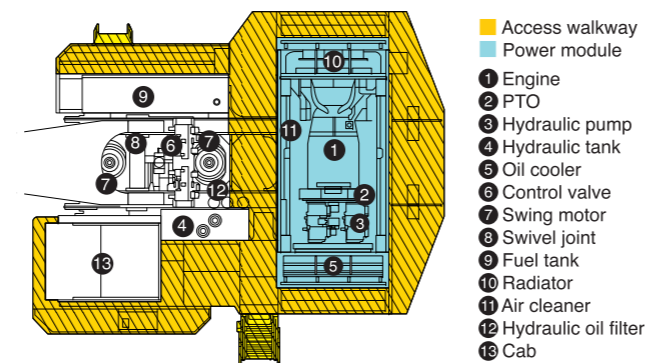

Centralized Filters

Centralized filters contribute to easy maintenance.

Remote Drain Piping Enables Drainage from the Ground

Remote drain piping provided to drain hydraulic oil, PTO oil, engine oil and coolant enable performing drainage work from the ground.

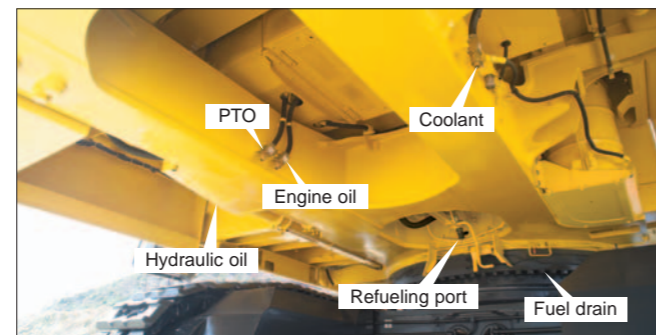

Ground Refueling System

Remote refueling port enables ground level refueling.



Large Fuel Tank

3400 ltr 898 U.S. gal large fuel tank enables continuous operation for 24 hours.

Service Center (optional)

Collective arrangement of drain and filler ports for fuel, oil, grease and coolant on the service center, which is hydraulically moved up and down, makes possible quick servicing from the ground.



Automatic Greasing System

Greasing work equipment and bucket is fully automated. Since the system carries out automatic greasing at regular time intervals, greasing is hassle-free.

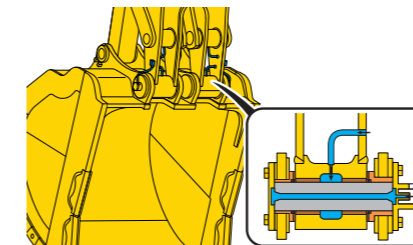

Jump Start Receptacle (optional)

Jump start receptacle allows starting engine from external power source.

Large Capacity Grease Tank and Easy-to-supply Refill Piping (optional)

The machine is equipped with 200 ltr 52.8 U.S.gal large capacity grease tank enough to perform 24 hours operation. An optional remote refill part enables grease supply to the tank from the ground.

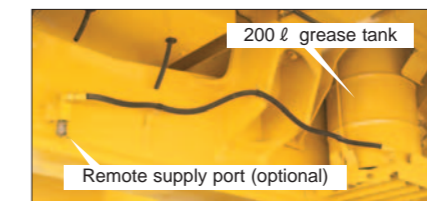

Dust Indicator with Five-step Indication

Informs of air cleaner clogging in five steps to warn of filter condition.



Battery Isolator and Starting Motor Isolator (optional)

When inspection and maintenance or storing the machine long term, the isolators serve to isolate both positive and negative terminals of the battery and starting motor.



Easy Cleaning of Radiator

The hydraulically driven fan can be reversed to facilitate cleaning of the cooling unit. In addition, this feature contributes to reducing warm-up time in low temperatures.

Fuel Pre-filter (with Water Separator)

Removes water and contaminants from fuel to enhance the fuel system reliability.

Reduced Maintenance Costs

Hydraulic oil filter replacement is extended from 500 to 1000 hours. Fuel filter replacement interval is extended from 500 to 1000 hours.



Hydraulic filter (Eco-white element)



Photo may include optional equipment.

COMFORT / WORKING ENVIRONMENT

*Operator first concept in every corner of the machine
An achievement in the evolution of operator performance*



Excellent Operational Visibility

Downward visibility is drastically improved by extending the front windshield. This facilitates the operator view of machine footing. New interior arrangement eliminates blind spots in work equipment side and provides clear and wide range surrounding visibility in combination with wide glass windows.

New Operator Cab Specially Designed for Mining

New operator cab provides a comfortable working environment. Sturdy cab of solid construction, with top guard conforms to OPG level 2.



OPG top guard level 2 integrated into the cab

Step Light with Timer and Maintenance Light

Step light with timer provides light for 90 seconds to allow the operator to get off the machine.



Hammer for Emergency Escape and Fire Extinguisher

To prepare for emergencies, a hammer for emergency escape is provided at the front of the cab and a fire extinguisher at the rear.

Hydraulic-actuated Ladder

The machine is equipped with a hydraulic-actuated ladder that can be set up and folded easily for safe getting on and off.



Emergency Stop Device & Fuel Cut-off Lever

Emergency stop device is provided at two points on the power module as standard equipment. Engine start lock function of the device for use during maintenance work. In addition, fuel cut-off lever provided on the revolving frame allows stopping the engine from the ground.



Emergency stop switch (with engine start lock function) Fuel cut-off lever

Engine emergency stop switch is additionally installed to the console in the cab as standard. The remote emergency stop switch operated from the ground is available as an option.

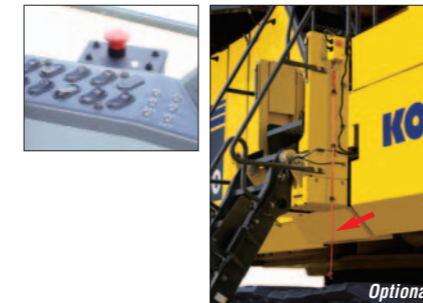

Interconnected Horn and Flashing Light

Allows the operator to give visual and audible notice to the dump truck operator.



Bulkhead Wall (Fire Wall)

Prevents oil from splashing into the engine room even if hydraulic hoses are broken.

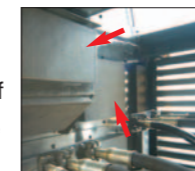

Stepladder for Emergency Escape

In case of an emergency, the stepladder allows you to get out of the machine.



High Intensity Discharge (HID) Working Light (optional)

HID working light with double the luminance of conventional halogen lamp is available for night work.

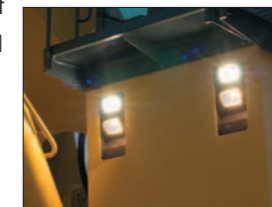

Dual Rearview Mirror

Mirrors offer high visibility with fewer blind spots in left rear field of vision.



Large Twin Wiper

Large twin wiper covers windshield area and provides excellent front visibility even in the rain.

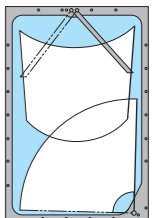

Wide Catwalk with Handrail

The machine is equipped with kickboard (100 mm 3.9" height) and large handrail all around.

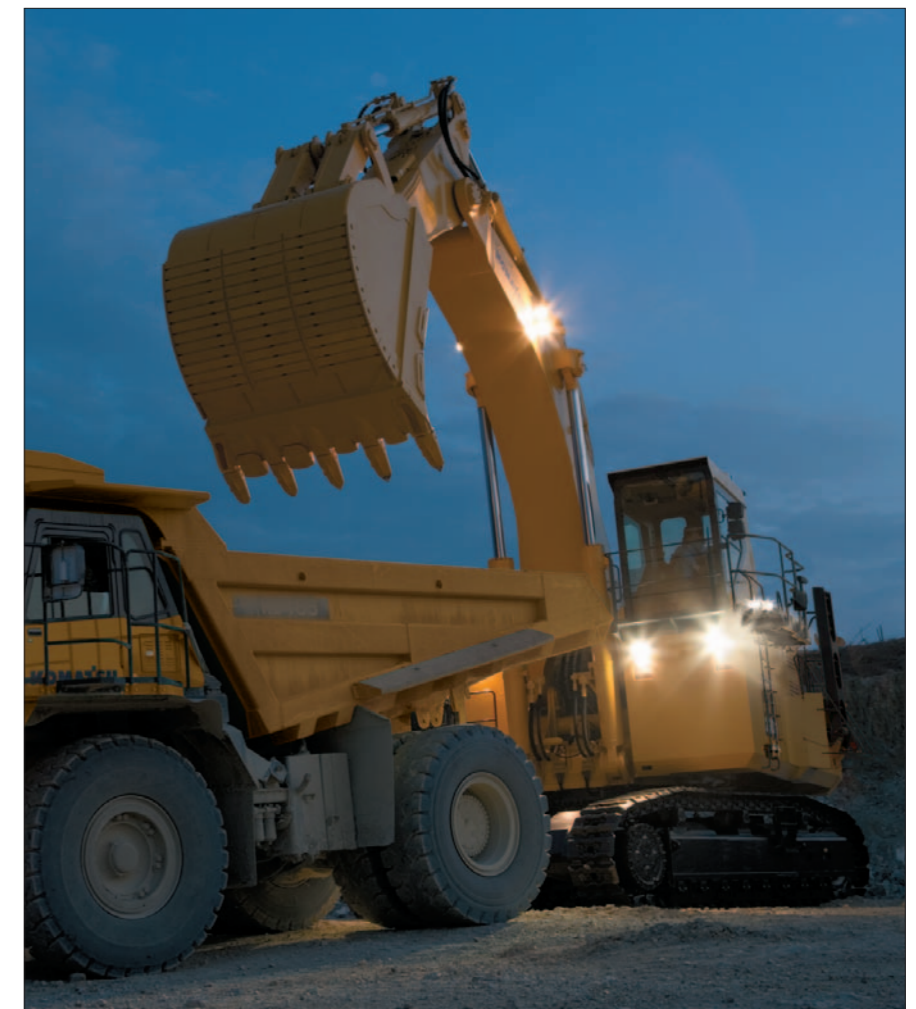

COMFORT / WORKING ENVIRONMENT

*Equipment designed to minimize operator fatigue
An achievement in the evolution of comfort performance*



Spacious and Comfortable New Cab Design

Large cab designed for exclusive use in mining shovels provides enough space to relax during operation. The cab with improved air tightness is pressurized to prevent dust from entering. Combined with a large capacity twin air conditioner that cools and heats the cab effectively, ample and comfortable operating environment is realized.

Cab volume 30% increased

Compared with PC1800-6

Comfortable Air Suspension Seat

The seat with air suspension minimizes and softens vibrations transmitted to the operator. Depending on the operator's weight and physique, the cushion can be adjusted and the seat can slide fore/aft and vertically.

Comfortable Operating Environment with Same Level of Low Noise as Passenger Cars

Integral structure of cab and new damper mounts, in combination with power module packaging, attain outstanding low noise and vibration in the cab equivalent to passenger cars.

Noise level 64.5 dB(A)

In the cab on max. engine speed under no-load condition

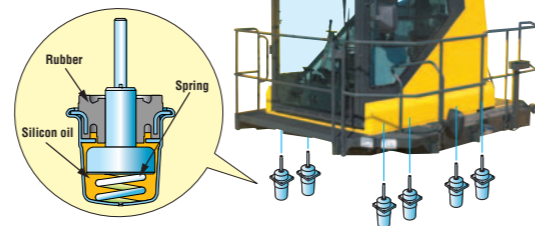

Easy-to-see and Easy-to-use 7-inch TFT-LCD Large Monitor

The machine is equipped with 7-inch TFT-LCD large monitor for secure, and smooth operation. Panel visibility is significantly improved by the use of the high-resolution TFT-LCD panel. The panel switch group is easy-to-use, enabling switch over of engine output and increase of lifting force during operation. Furthermore, use of function key enables the operator to perform multi-functions with ease. Character display can be selected among nine languages.



Indicators			Basic operation switches		
1	Wiper (ON: Continuous/INT: Intermittent)	13	Hydraulic oil temperature gauge (switchable to engine oil temperature display)	1	Auto deceleration
2	Swing holding brake	14	Fuel level gauge (switchable to engine oil temperature gauge display)	2	Working mode selection
3	Engine preheating	15	Fuel level gauge (switchable to engine oil temperature display)	3	Heavy lift mode selection
4	Automatic greasing	16	Truck loading counter	4	Buzzer cancel
5	Engine stop caution	17	Eco-gauge	5	Wiper
6	Digital clock (switchable to service meter display)	18	Function switch menu	6	Window washer
7	Auto deceleration	19	Function switch display		
8	Working mode				
9	Heavy lift mode				
10	Coolant temperature gauge (switchable to PTO temperature gauge display)				
11	Coolant temperature gauge (switchable to PTO temperature display)				
12	Hydraulic oil temperature gauge (switchable to engine oil temperature gauge display)				



Standard Equipment



SPECIFICATIONS



ENGINE

Model Komatsu SAA12V140E-3
 Type 4-cycle, water-cooled, direct injection
 Aspiration Turbocharged, aftercooled
 Number of cylinders 12
 Bore 140 mm 5.51"
 Stroke 165 mm 6.50"
 Piston displacement 30.48 ltr 1860 in³
 Governor All-speed, electronic
 Horsepower:
 SAE J1995 Gross 728 kW 976 HP
 ISO 9249 / SAE J1349* Net 713 kW 956 HP
 Rated rpm 1800 rpm
 Fan drive type Hydraulic

*Net horsepower at the maximum speed of radiator cooling fan is 679 kW 910HP.
 EPA Tier 2 emission certified



HYDRAULIC SYSTEM

Type Open-center load sensing system
 Number of selectable working modes 2

Main pump:
 Type Variable displacement piston pumps
 Pumps for Boom, arm, bucket, swing and travel circuits

Maximum flow:
 For attachment, swing and travel. . . 2317 ltr/min 612.2 U.S. gpm
 For fan drive 324 ltr/min 85.6 U.S. gpm

Hydraulic motors:
 Travel 2 x axial piston motors with parking brake
 Swing 2 x axial piston motors with swing holding brake
 Fan 2 x axial piston motors

Relief valve setting:
 Attachment circuits
 Backhoe 29.4 MPa 300 kgf/cm² 4,270 psi
 Loading shovel 29.4 MPa 300 kgf/cm² 4,270 psi
 Travel circuit 32.9 MPa 335 kgf/cm² 4,760 psi
 Swing circuit 29.4 MPa 300 kgf/cm² 4,270 psi
 Pilot circuit 2.9 MPa 30 kgf/cm² 430 psi

Hydraulic cylinders:
 Number of cylinders—bore x stroke
 Backhoe
 Boom 2 – 300 mm x 2647 mm 11.8" x 104.2"
 Arm 2 – 250 mm x 2138 mm 9.8" x 84.2"
 Bucket 2 – 200 mm x 2170 mm 7.9" x 85.4"

Loading shovel
 Boom 2 – 280 mm x 1930 mm 11.6" x 76.0"
 Arm 2 – 200 mm x 2170 mm 7.9" x 85.4"
 Bucket 2 – 225 mm x 2050 mm 8.9" x 80.7"
 Bottom dump 2 – 180 mm x 600 mm 7.1" x 23.1"



SWING SYSTEM

Swing gear 2 x Planetary gear
 Swing circle lubrication Grease
 Swing holding brakes Mechanical disk brakes
 Swing speed 4.8 rpm



DRIVE SYSTEM

Travel gear Planetary gear
 Gradeability 65%
 Maximum travel speed 2.7 km/h 1.7 mph
 Parking brakes Mechanical disk brakes



UNDERCARRIAGE

Track adjuster Grease
 No. of shoes 49 each side
 No. of carrier rollers 3 each side
 No. of track rollers 8 each side



COOLANT AND LUBRICANT CAPACITY (REFILLING)

Fuel tank 3400 ltr 898.3 U.S. gal
 Radiator 180 ltr 47.6 U.S. gal
 Engine 120 ltr 31.7 U.S. gal
 Travel gear, each side 85 ltr 22.5 U.S. gal
 Swing drives 30 x 2 ltr 7.9 x 2 U.S. gal
 Hydraulic tank 1300 ltr 343.5 U.S. gal
 PTO 30 ltr 7.9 U.S. gal



OPERATING WEIGHT (APPROXIMATE)

BACKHOE
 Operating weight, including 8700 mm 28'7" boom, 3900 mm 12'10" arm, SAE heaped 12.0 m³ 15.7 yd³ general purpose backhoe bucket, operator, lubricant, coolant, full fuel tank, and the standard equipment.

Shoes	PC2000-8	
	Operating Weight	Ground Pressure
Double grouser 810 mm 32"	200000 kg 440,920 lb	190 kPa 1.94 kgf/cm ² 27.6 psi
Triple grouser 1010 mm 40"	204120 kg 450,000 lb	156 kPa 1.59 kgf/cm ² 22.6 psi

LOADING SHOVEL
 Operating weight, including 5950 mm 19'6" boom, 4450 mm 14'7" arm, 11.0 m³ 14.4 yd³ heaped bucket, operator, lubricants, coolant, full fuel tank and standard equipment.

Shoes	PC2000-8	
	Operating Weight	Ground Pressure
Double grouser 810 mm 32"	195000 kg 429,900 lb	186 kPa 1.90 kg/cm ² 27.0 psi



BACKHOE DIMENSIONS

Unit: mm ft in

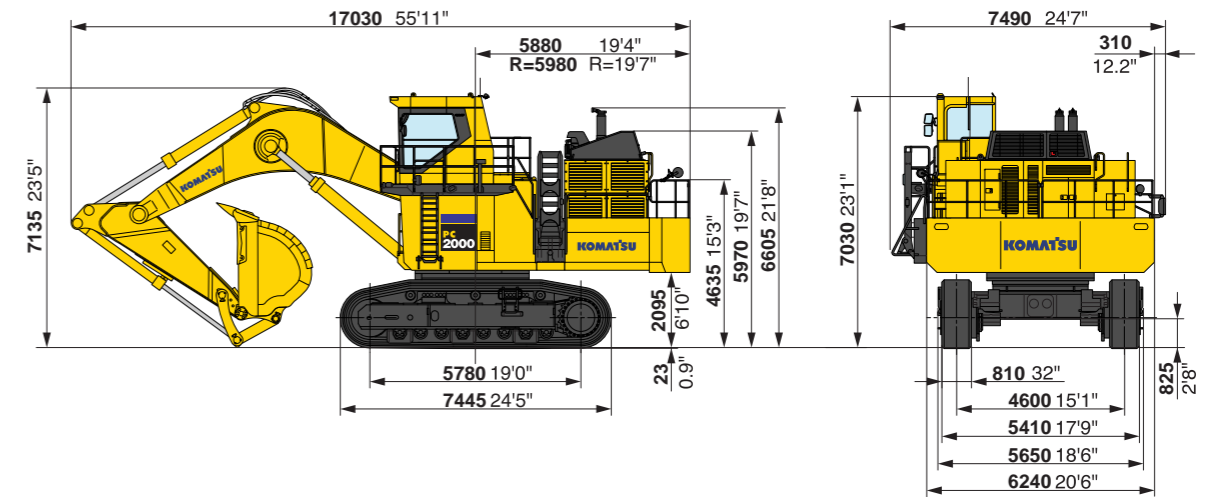

BACKHOE WORKING RANGE

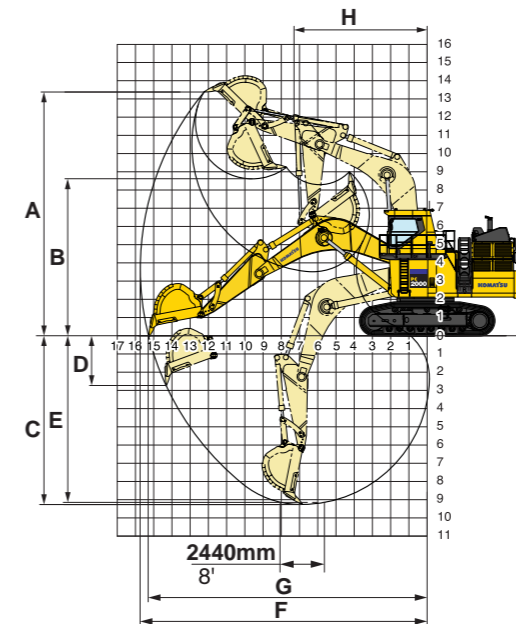

Boom length	8.7 m 28'7"
Arm length	3.9 m 12'10"
A Max. digging height	13410 mm 44'0"
B Max. dumping height	8650 mm 28'5"
C Max. digging depth	9235 mm 30'4"
D Max. vertical wall digging depth	2710 mm 8'11"
E Max. digging depth of cut for 8' level	9115 mm 29'11"
F Max. digging reach	15780 mm 51'9"
G Max. digging reach at ground level	15305 mm 50'3"
H Min. swing radius	7500 mm 24'7"
Bucket digging force (SAE)	626 kN 63800 kgf / 140,650 lb
Arm crowd force (SAE)	574 kN 58500 kgf / 128,970 lb
Bucket digging force (ISO)	697 kN 71100 kgf / 156,750 lb
Arm crowd force (ISO)	586 kN 59800 kgf / 131,840 lb



BACKHOE BUCKET

BUCKET CAPACITY (HEAPED)		WIDTH		WEIGHT (with Side Shrouds) kg lb	MAX MATERIAL DENSITY (Loose) t / m ³ lb / yd ³	RECOMMENDED USES	TOOTH SYSTEM
SAE, PCSA m ³ yd ³	CECE m ³ yd ³	Without Side Shrouds mm in	With Side Shrouds mm in				
*12.0 15.7	11.0 14.4	2600 102"	2670 105"	12400 27,340	1.8 3000	Rock	XS145
12.0 15.7	11.0 14.4	2600 102"	2670 105"	9700 21,380	1.8 3000	General purpose	XS145
*13.7 17.9	12.0 15.7	2720 107"	2790 110"	12500 27,560	1.5 2500	Rock	XS145
13.7 17.9	12.0 15.7	2720 107"	2790 110"	10500 23,150	1.5 2500	General purpose	XS145

These charts are based on over-side stability with fully loaded bucket at maximum reach.

*: Wear-resistant bucket

LOADING SHOVEL DIMENSIONS

Unit: mm ft in

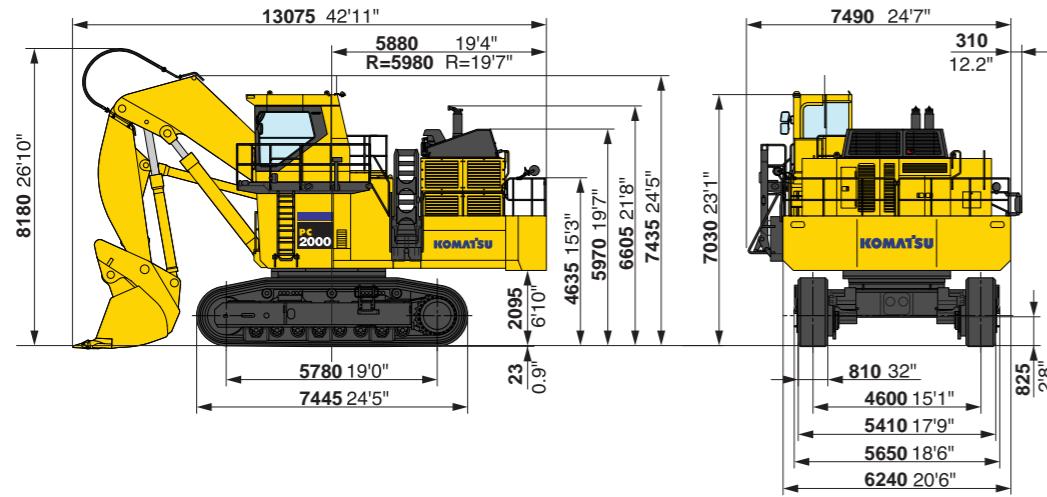

LOADING SHOVEL WORKING RANGE

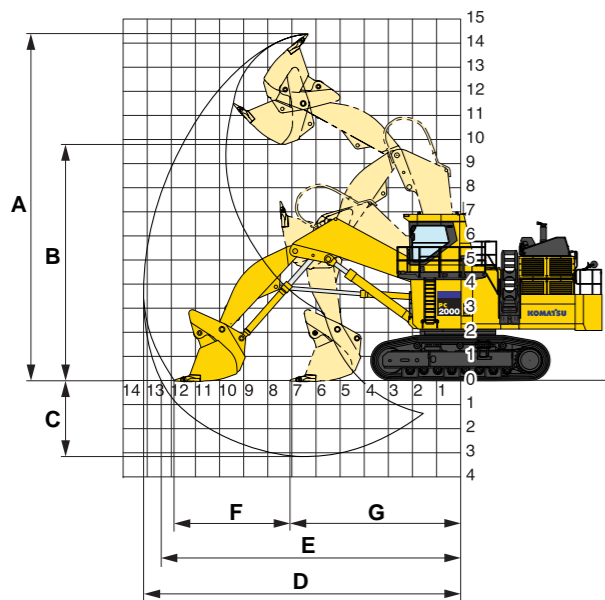

Working Range

Type of bucket	Bottom dump	
Capacity-heaped	11.0 m ³	14.4 yd ³
A Max. cutting height	14450 mm	47'5"
B Max. dumping height	9665 mm	31'9"
C Max. digging depth	3190 mm	10'6"
D Max. digging reach	13170 mm	43'3"
E Max. digging reach at ground level	11940 mm	39'2"
F Level crowding distance	4850 mm	15'11"
G Min. crowd distance	7090 mm	23'3"
Bucket digging force	721 kN 73500 kgf / 162,040 lb	
Arm crowd force	755 kN 77000 kgf / 169,750 lb	

LOADING SHOVEL BUCKET

Type of bucket	Bottom dump	
Capacity-heaped	11.0 m ³	14.4 yd ³
Width (with side shrouds)	3220 mm	127"
Weight	14400 kg	31,750 lb
Tooth system	XS145	
No. of bucket teeth	6	
Max. material density	1.8 t/m ³	3000 lb/yd ³

LIFTING CAPACITY

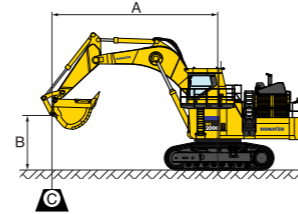

PC2000-8

- Equipment:
- Boom: 8.7 m 28'7"
 - Arm: 3.9 m 12'10"
 - Bucket: 12.0 m³ 15.7 yd³
 - Bucket weight: 9700 kg 21,380 lb
 - Track shoe width: 810 mm 32"

- A: Reach from swing center
B: Bucket hook height
C: Lifting capacity
Cf: Rating over front
Cs: Rating over side
Cmax: Rating at maximum reach

Heavy Lift Off

Unit: kg lb

B	A	Maximum		10.7 m 35'		9.1 m 30'		7.6 m 25'		6.1 m 20'		4.6 m 15'		3.0 m 10'	
		Cf	Cs	Cf	Cs	Cf	Cs	Cf	Cs	Cf	Cs	Cf	Cs	Cf	Cs
7.6 m 25'		*21050 *46,400	*21050 *46,400	*31450 *69,300	*31450 *69,300										
6.1 m 20'		*21950 *48,400	*21950 *48,400	*33350 *73,500	*33350 *73,500	*38650 *85,200	*38650 *85,200	*46700 *102,900	*46700 *102,900						
4.6 m 15'		*23400 *51,500	*23400 *51,500	*35400 *78,000	*35400 *78,000	*42000 *92,500	*42000 *92,500	*52200 *115,000	*52200 *115,000						
3.0 m 10'		*25500 *56,100	24100 53,100	*37150 *81,900	36050 79,400	*44850 *98,800	*44850 *98,800	*56550 *124,700	*56550 *124,700						
1.5 m 5'		*28450 *62,700	24150 53,200	*38300 *84,400	34650 76,300	*46650 *102,900	44900 99,000	*59050 *130,100	*59050 *130,100	*61150 *134,800	*61150 *134,800				
0 m 0'		*29800 *65,700	25050 55,200	*38500 *84,800	33600 74,100	*47150 *103,900	43450 95,800	*59400 *130,900	58650 129,300	*68850 *151,800	*68850 *151,800				
-1.5 m -5'		*30250 *66,600	27000 59,500	*37200 *82,000	33100 73,000	*45950 *101,300	42750 94,200	*57550 *126,800	*57550 *126,800	*73500 *162,000	*73500 *162,000	*48800 *107,500	*48800 *107,500	*33650 *74,200	*33650 *74,200
-3.0 m -10'		*30350 *66,900	*30350 *66,900	*33700 *74,300	33200 73,200	*42650 *94,000	*42650 *94,000	*53300 *117,400	*53300 *117,400	*67000 *147,700	*67000 *147,700	*68250 *150,400	*68250 *150,400	*50150 *110,600	*50150 *110,600
-4.6 m -15'		*29750 *65,500	*29750 *65,500			*36050 *79,400	*36050 *79,400	*45850 *101,100	*45850 *101,100	*57200 *126,000	*57200 *126,000	*70850 *156,200	*70850 *156,200	*69500 *153,200	*69500 *153,200
-6.1 m -20'		*27000 *59,500	*27000 *59,500					*33150 *73,100	*33150 *73,100	*42200 *93,000	*42200 *93,000	*50800 *111,900	*50800 *111,900		

* Load is limited by hydraulic capacity rather than tipping. Ratings are based on SAE standard No. J/ISO10567. Rated loads do not exceed 87% of hydraulic lift capacity or 75% of tipping load.

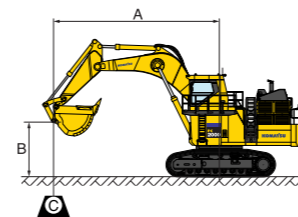

PC2000-8

- Equipment:
- Boom: 8.7 m 28'7"
 - Arm: 3.9 m 12'10"
 - Bucket: 12.0 m³ 15.7 yd³
 - Bucket weight: 9700 kg 21,380 lb
 - Track shoe width: 810 mm 32"

- A: Reach from swing center
B: Bucket hook height
C: Lifting capacity
Cf: Rating over front
Cs: Rating over side
Cmax: Rating at maximum reach

Heavy Lift On

Unit: kg lb

B	A	Maximum		10.7 m 35'		9.1 m 30'		7.6 m 25'		6.1 m 20'		4.6 m 15'		3.0 m 10'	
		Cf	Cs	Cf	Cs	Cf	Cs	Cf	Cs	Cf	Cs	Cf	Cs	Cf	Cs
7.6 m 25'		*23900 *52,700	*23900 *52,700	*36150 *79,600	*36150 *79,600										
6.1 m 20'		*24850 *54,800	*24850 *54,800	*38350 *84,500	*38350 *84,500	*44150 *97,300	*44150 *97,300	*52950 *116,700	*52950 *116,700						
4.6 m 15'		*26450 *58,200	24800 54,700	*40700 *89,700	37700 83,100	*48000 *105,800	*48000 *105,800	*59350 *130,800	*59350 *130,800						
3.0 m 10'		*28700 *63,200	24100 53,100	*42800 *94,300	36050 79,400	*51300 *113,100	47050 103,700	*64450 *142,000	63650 140,300						
1.5 m 5'		*31950 *70,400	24150 53,200	*44150 *97,300	34650 76,300	*53500 *117,900	44900 99,000	*67350 *148,500	60500 133,400	*62850 *138,600	*62850 *138,600				
0 m 0'		*34100 *75,200	25050 55,200	*44400 *97,900	33600 74,100	*54150 *119,400	43450 95,800	*67900 *149,600	58650 129,300	*62450 *137,600	*62450 *137,600				
-1.5 m -5'		*35300 *77,800	27000 59,500	*43100 *95,000	33100 73,000	*52900 *116,600	42750 94,200	*65950 *145,300	57850 127,500	*62950 *138,800	*62950 *138,800	*54150 *119,300	*54150 *119,300	*37650 *83,000	*37650 *83,000
-3.0 m -10'		*35550 *78,300	30600 67,400	*39250 *86,500	33200 73,200	*49300 *108,600	42700 94,100	*61300 *135,100	57500 127,800	*64650 *142,500	*64650 *142,500	*61500 *135,600	*61500 *135,600	*55650 *122,700	*55650 *122,700
-4.6 m -15'		*34950 *77,000	*34950 *77,000			*42000 *92,600	*42000 *92,600	*53100 *117,100	*53100 *117,100	*66000 *145,500	*66000 *145,500	*62200 *137,100	*62200 *137,100	*62000 *136,600	*62000 *136,600
-6.1 m -20'		*32150 *70,800	*32150 *70,800					*39150 *86,200	*39150 *86,200	*49500 *109,100	*49500 *109,100	*59650 *131,500	*59650 *131,500		

* Load is limited by hydraulic capacity rather than tipping. Ratings are based on SAE standard No. J/ISO10567. Rated loads do not exceed 87% of hydraulic lift capacity or 75% of tipping load.

Specifications shown include the following equipment:

Backhoe: boom 8700 mm 28'7", arm 3900 mm 12'10", bucket 12.0 m³ 15.7 yd³, shoes 810 mm 32" double grouser

Loading Shovel: boom 5950 mm 19'6", arm 4450 mm 14'7", bucket 11.0 m³ 14.4 yd³, shoes 810 mm 32" double grouser

Work equipment assembly-backhoe

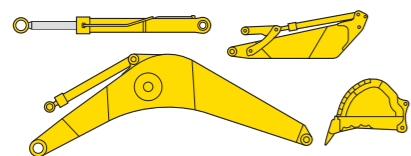

	Length mm ft in	Width mm ft in	Height mm ft in	Weight t U.S. ton
Boom	9170 30'1"	2065 6'9"	3195 10'6"	20.9 23.0
Arm	5495 18'0"	1605 5'3"	2055 6'9"	12.9 14.2
Bucket	3540 11'7"	2790 9'2"	2320 7'7"	9.7 10.7

	Length mm ft in	Weight t U.S. ton	Quantity
Boom cylinder	4265 14'0"	2.4 2.7	2

Work equipment assembly-Loading Shovel

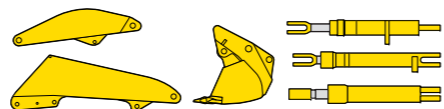

	Length mm ft in	Width mm ft in	Height mm ft in	Weight t U.S. ton
Boom	6400 21'0"	1740 5'9"	2000 6'7"	11.8 13.0
Arm	4900 16'1"	1450 4'9"	1700 5'7"	9.5 10.5
Bucket	3500 11'6"	3190 10'6"	2920 9'7"	14.4 15.9

	Length mm ft in	Weight t U.S. ton	Quantity
Boom cylinder	4265 14'0"	1.90 2.09	2
Arm cylinder	3370 11'9"	1.05 1.16	2
Bucket cylinder	3350 11'0"	1.10 1.21	2

Cab

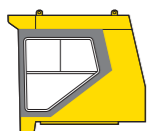

Cab base



Revolving frame

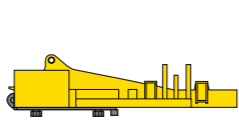

Power module

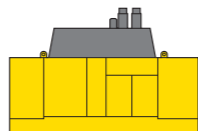

Fuel tank

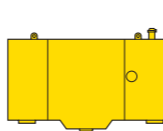

	Length mm ft.in	Width mm ft.in	Height mm ft.in	Weight t U.S. ton
Cab	2885 9'6"	1880 6'2"	2520 8'3"	1.8 1.98
Cab base	3660 12'0"	2505 8'3"	2700 8'10"	2.5 2.8
Revolving frame	7575 24'10"	3180 10'5"	2640 8'8"	26.5 29.2
Power module	5215 17'1"	2455 8'1"	3195 10'6"	16.1 17.7
Fuel tank	3100 10'2"	875 2'10"	2070 6'10"	2.4 2.65

Counter weight



Center frame

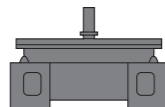

Undercarriage

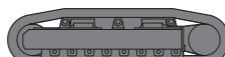

Hydraulic tank



	Length mm ft.in	Width mm ft.in	Height mm ft.in	Weight t U.S. ton
Counter weight	6420 21'1"	1115 3'8"	1505 4'11"	24.5 27.0
Center frame	3815 12'6"	3190 10'6"	2210 7'3"	18.0 19.8
Undercarriage	7435 24'5"	1720 5'8"	1920 6'4"	26.0 x 2 28.65 x 2
Hydraulic tank	1860 6'1"	1115 3'8"	2125 7'0"	3.5 3.86

Others

Catwalk, step, handrail, small removed parts, etc.

ENGINE AND RELATED ITEMS:

- Air cleaner, double element dry (Inside mounted)
- Two cooling fans with fan guard (Hydraulic driven, for radiator and oil cooler)
- Engine, Komatsu SAA12V140E-3
- Fuel pre-filters with water separators

ELECTRICAL SYSTEM:

- Alternators, 2 x 90 amp, 24V
- Batteries, 140 Ah, 4 x 12V
- Starting motors, 2 x 11 kW
- Working lights, 4 on boom, 4 on cab base, 3 on fuel tank top front, 1 left front and 1 left under cab side catwalk
- Auto-decelerator and auto-idling system
- AM/FM radio
- Lighting switches on instrument panel

UNDERCARRIAGE:

- 810 mm 32" double grouser shoes
- 8 track rollers / 3 carrier rollers (each side)
- Hydraulic idler cushion (HIC) with shock absorbing accumulator
- Track guiding guard (Separate type)

GUARDS AND COVERS:

- Dustproof net for radiator and oil cooler
- Pump/engine room partition cover
- Power module under cover
- Travel motor guard

OPERATOR'S CAB:

- Large damper mounted and pressurized mining shovel cab with large tinted windshield, lockable door, large twin wipers and washers, floor mats, cigarette lighter, ashtray and cup holders
- Instrument panel with electronic display/monitor system (7"-TFT-LCD), electrically-controlled throttle dial, electric service meter, gauges (coolant temperature, hydraulic oil temp., fuel level, PTO oil temp., engine oil temp.), truck counters, eco-gauge
- Built-in top guard conforming to OPG level 2 (ISO)
- Automatic air conditioners (twin)
- Seat, fully adjustable air suspension with retractable seat belt
- Trainer's seat
- Sun shield
- Fire extinguisher
- Emergency engine stop switch
- Lock lever

HYDRAULIC SYSTEM:

- E-OLSS (Electronic Open Center Load Sensing System)
- 4 variable displacement piston pumps (2 tandem pumps) for work equipment, travel and swing, 2 variable displacement piston pumps (1 tandem pump) for fan drive
- Two axial piston motors for swing with single stage relief valve
- One axial piston motor per track for travel with counterbalance valve
- Four control valves (two integrated valves) for work equipment, swing and travel
- Control levers for work equipment and swing with PPC system
- Control levers and pedals for travel with PPC system
- Oil cooler
- High-pressure in-line oil filters
- Drain-filters for pumps & motors
- Shockless boom control
- Two-mode pressure setting for boom

DRIVE SYSTEM:

- Planetary travel gear with axial piston motor
- Travel parking brake

OTHER STANDARD EQUIPMENT:

- Fully-automatic greasing system with 200 liter 52.8 U.S. gal.
- Manual grease gun for track adjuster
- Hydraulic-actuated ladder
- Step ladder for emergency escape
- Fuel tank, 3400 liter 898 U.S. gal.
- Refueling port
- Automatic swing holding brake
- Emergency engine stop switch and fuel cut-off lever
- Maintenance light
- Step light with timer
- Light in machine cab
- Travel alarm
- Wide catwalk with kickboard (100 mm 3.9" height) and large handrail
- Interconnected horn and flashing light
- Dual rearview mirrors
- VHMS

- Additional 6 fuses and terminals
- Arms (Backhoe):
—3900 mm 12'10" arm assembly
- Arms (Loading shovel):
—4450 mm 14'7" arm assembly
- Booms (Backhoe):
—8700 mm 28'7" boom assembly
- Booms (Loading shovel):
—5950 mm 19'6" boom assembly
- HID lamp system
- Rearview monitoring system
- Cab front guard
- PM tune-up service connection

- Track shoe, 1010 mm 40" triple grouser
- Center frame under cover
- Grease refill system
- Service center (Grease shut-off valve available to order)
- Isolators, battery and starter
- Jump start receptacle
- Satellite communication system for VHMS (Orbcomm)
- Heavy-duty rock bucket
- 55°C spec.
- Additional filter system for poor-quality fuel
- Additional pre-cleaner for engine air filter (Enginaire)
- Full length track guiding guards

